

REVISIONS LIST				
REV	ECO #	DESCRIPTION	DATE	APV ' D
A		Initial Release		

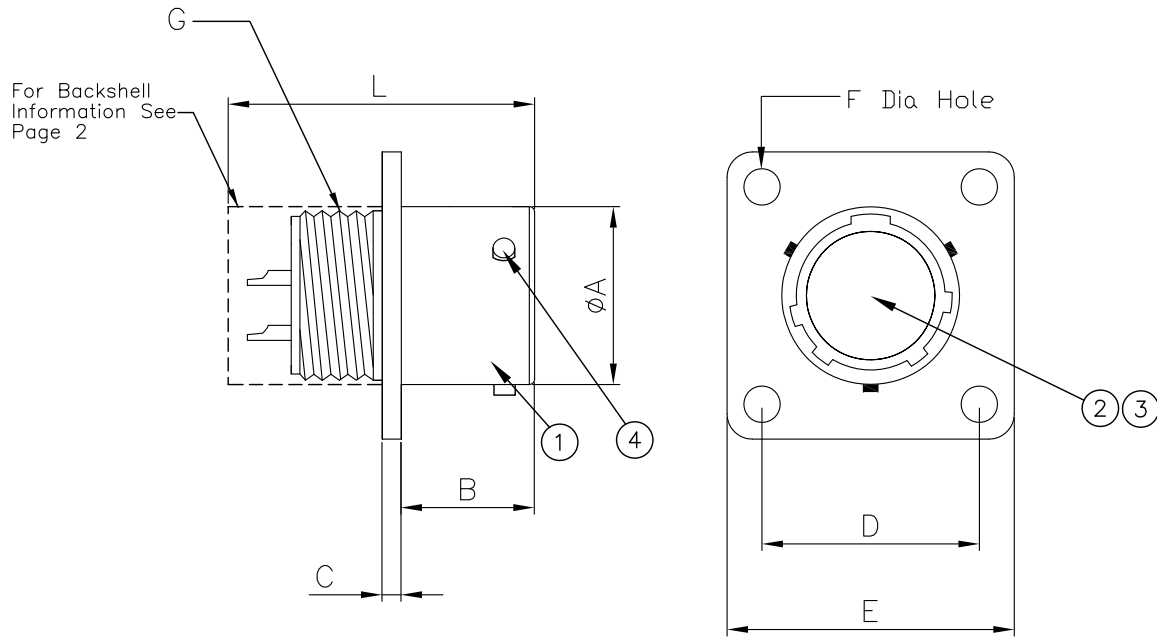

For Backshell Information See Page 2

SPECIFICATIONS

Mechanical	
Engagement Force-Torque (Max)	.902-4.97 N-m
Disengagement Force-Torque (Min)	.113-.791 N-m
Durability	500 Cycles
Insert Retention	5.3 Kg/cm ²
Contact Retention (Min)	
20 Gauge	67 N
16 Gauge	113 N
Contact Engagement Force (Max)	
20 Gauge	5.0 N
16 Gauge	8.34 N
Contact Separation Force (Min)	
20 Gauge	.195 N
16 Gauge	.556 N
Electrical	
Current Rating (Max)	
20 Gauge	7.5A
16 Gauge	22.0A
Contact Resistance	As specified in Table VII MIL-DTL-26482
Insulation Resistance (@500 VDC)	
(25°C)	5000 MΩ
Short Time (125°C)	3 MΩ
Long Time (105°C)	12 MΩ
Dielectric Withstanding Voltage (Working)	
SL (Service Rating I)	600 VAC (rms)
(Service Rating II)	1000 VAC (rms)
70,000 Ft (Service Rating I)	300 VAC (rms)
(Service Rating II)	450 VAC (rms)
Environmental	
Operating Temperature	-55°C - +125°C
Air Leakage (@2.11 Kg/cm ²)	<4.55X10 ⁻³ cm ³ /s
Salt Spray (@35°C)	48 Hrs
Vibration (10-2000Hz)	12 Hrs
Shock (Peak Acceleration)	490 m/s ² (50g's)

Shell Size	A MAX	B +0.79 -0.00	C ±0.41	D TP	E MAX	F ±0.127	G THREAD (UNEF2A)
8	12.04	10.95	1.57	15.08	21.03	3.05	.4375-28
10	15.01	10.95	1.57	18.26	24.23	3.05	.5625-24
12	19.08	10.95	1.57	20.62	26.60	3.05	.6875-24
14	22.25	10.95	1.57	23.01	28.98	3.05	.8125-20
16	25.43	10.95	1.57	24.61	31.34	3.05	.9375-20
18	28.60	10.95	1.57	26.97	33.73	3.05	1.0625-18
20	31.78	14.12	2.38	29.41	36.90	3.05	1.1875-18
22	34.95	14.12	2.38	31.75	40.08	3.05	1.3125-18
24	38.12	14.96	2.38	34.92	43.18	3.73	1.4375-18

NOTE: Service Rating is identified on each insert arrangement

No.	Name	Material/Finish	Remarks
1	Shell	Aluminum	
2	Insert	Neoprene	
3	Contact	Copper Alloy	Ni 100μ" - Au 50μ"
4	Locking Post	304 Stainless Steel	

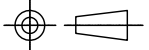
UNLESS NOTED TOLERANCES ARE: .X ± 0.38 .XX ± 0.25 ANGLES ± 1°	THIRD ANGLE PROJECTION		1170 S. PATTON ST. XENIA, OHIO 45385 PH: (937) 374-2700 FX: (937) 374-2717
			
UNIT: mm	DRWN: RLM	TITLE	
SCALE: NTS	DATE: 01/29/14	MIL-DTL-26482 Wall Mount Receptacle	
	CHK'D: RLM	S P I P / N : MS3110XXX-XXXX	
SHEET: 1 OF 2	APV'D: RLM	C U S T O M E R P / N :	

THESE DRAWINGS AND SPECIFICATIONS ARE THE PROPERTY OF SPI AND SHALL NOT BE COPIED, USED OR REPRODUCED WITHOUT PERMISSION.

REV: A

REVISIONS LIST				
REV	ECO #	DESCRIPTION	DATE	APV'D
A		Initial Release		

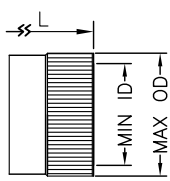

GROMMET SEAL WITH BACK NUT [E]

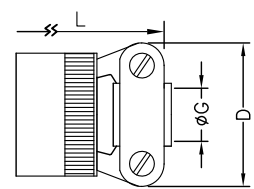

GROMMET SEAL WITH STRAIN RELIEF [F]

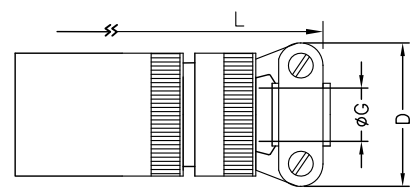

WATER TIGHT GLAND SEAL WITH STRAIN RELIEF [J]

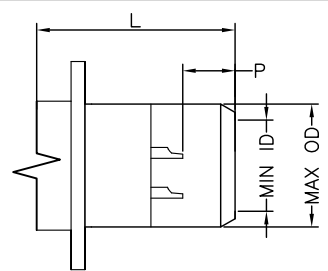

ENVIRONMENTAL POTTING [P]

Shell Size	CLASS E			CLASS F			CLASS J				CLASS P			
	L MAX	ID MIN	OD MAX	L MAX	D MAX	$\phi G \pm .254$	L MAX	D MAX	GLAND CLOSED	ϕG OPEN	L MAX	ID MIN	OD MAX	P MIN
8	33.73	6.58	15.44	48.82	21.03	3.18	57.68	21.03	4.29	5.84	36.91	8.05	15.44	6.35
10	33.73	9.12	18.64	48.82	22.63	4.78	57.68	22.63	5.21	7.92	39.91	11.02	18.64	6.35
12	33.73	11.91	21.79	48.82	25.81	7.92	61.24	25.81	8.59	11.23	36.91	13.92	21.79	6.35
14	33.73	14.96	24.99	48.82	28.98	9.53	66.01	28.98	10.57	13.69	36.91	17.09	24.99	6.35
16	33.73	18.47	28.19	51.99	30.56	12.70	74.75	30.56	13.97	15.65	36.91	20.27	28.19	6.35
18	33.73	19.79	31.34	52.78	37.31	15.88	80.57	37.31	15.24	17.07	36.91	22.83	31.34	6.35
20	38.89	22.89	34.54	59.54	37.31	15.88	91.69	37.31	16.13	18.97	42.47	26.01	34.54	6.35
22	38.89	25.63	37.69	59.54	42.06	19.05	95.66	42.06	17.02	21.49	42.47	29.18	37.69	6.35
24	40.49	28.52	40.89	61.11	44.45	20.32	101.22	44.45	19.30	22.69	44.04	32.36	40.89	6.35

Name	Material/Finish	Remarks
Back Shells & Clamps	Aluminum	
Screws	Brass	
Washers	Stainless Steel	F & J Back Shells
Grommets/O-Rings	Neoprene	
Gland Seal	Silicone	

UNLESS NOTED TOLERANCES ARE: .X \pm 0.38 .XX \pm 0.25 ANGLES \pm 1°	THIRD ANGLE PROJECTION 	 1170 S. PATTON ST. XENIA, OHIO 45385 PH: (937) 374-2700 FX: (937) 374-2717
UNIT: mm	DRWN: RLM	TITLE MIL-DTL-26482 Wall Mount Receptacle S P I P / N : MS3110XXX-XXXX C U S T O M E R P / N :
SCALE: NTS	DATE: 01/29/14	
	CHK'D: RLM	
SHEET: 2 OF 2	APV'D: RLM	

THESE DRAWINGS AND SPECIFICATIONS ARE THE PROPERTY OF **SPI** AND SHALL NOT BE COPIED, USED OR RE-PRODUCED WITHOUT PERMISSION.

REV: A