

REVISIONS LIST				
REV	ECO #	DESCRIPTION	DATE	APV'D
A		Initial Release		
B		Add New Insert Material	05/05/17	RLM

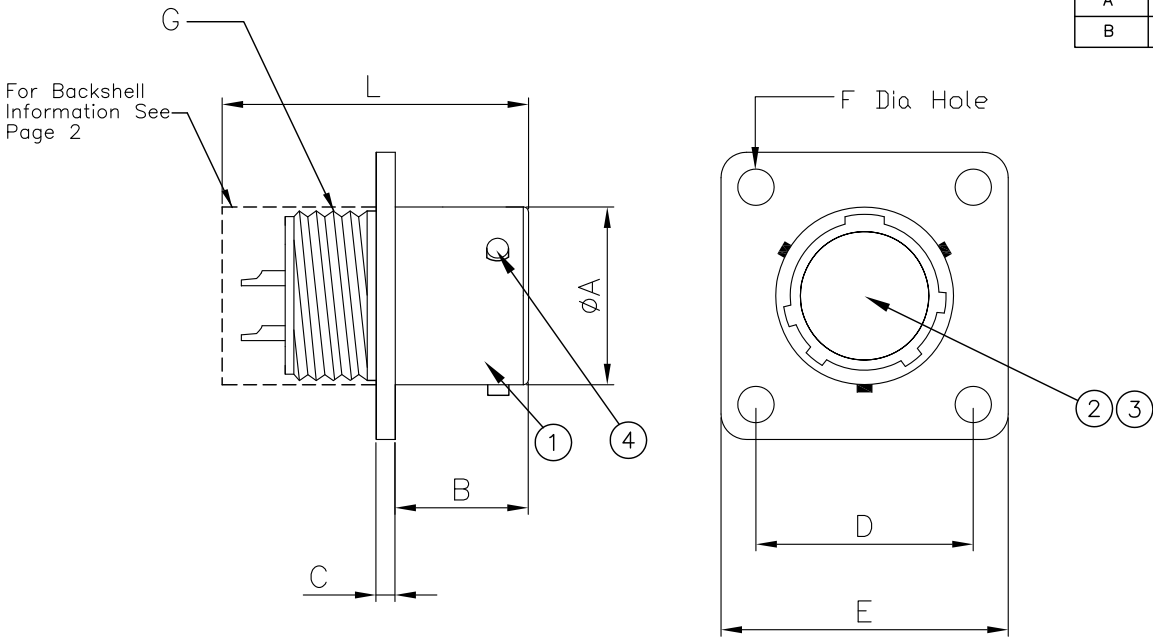

For Backshell Information See Page 2

SPECIFICATIONS

<u>Mechanical</u>	
Engagement Force-Torque (Max)	.902-4.97 N-m
Disengagement Force-Torque (Min)	.113-.791 N-m
Durability	500 Cycles
Insert Retention	5.3 Kg/cm ²
Contact Retention (Min)	
20 Gauge	67 N
16 Gauge	113 N
Contact Engagement Force (Max)	
20 Gauge	5.0 N
16 Gauge	8.34 N
Contact Separation Force (Min)	
20 Gauge	.195 N
16 Gauge	.556 N
<u>Electrical</u>	
Current Rating (Max)	
20 Gauge	7.5A
16 Gauge	22.0A
Contact Resistance	As specified in Table VII MIL-DTL-26482
Insulation Resistance (@500 VDC)	
(25°C)	5000 MΩ
Short Time (125°C)	3 MΩ
Long Time (105°C)	12 MΩ
Dielectric Withstanding Voltage (Working)	
SL (Service Rating I)	600 VAC (rms)
(Service Rating II)	1000 VAC (rms)
70,000 Ft (Service Rating I)	300 VAC (rms)
(Service Rating II)	450 VAC (rms)
<u>Environmental</u>	
Operating Temperature	-55°C - +125°C
Air Leakage (@2.11 Kg/cm ²)	<4.55x10 ⁻³ cm ³ /s
Salt Spray (@35°C)	48 Hrs
Vibration (10-2000Hz)	12 Hrs
Shock (Peak Acceleration)	490 m/s ² (50g's)

Shell Size	A MAX	B +0.79 -0.00	C ±0.41	D TP	E MAX	F ±0.127	G THREAD (UNEF2A)
8	12.04	10.95	1.57	15.08	21.03	3.05	.4375-28
10	15.01	10.95	1.57	18.26	24.23	3.05	.5625-24
12	19.08	10.95	1.57	20.62	26.60	3.05	.6875-24
14	22.25	10.95	1.57	23.01	28.98	3.05	.8125-20
16	25.43	10.95	1.57	24.61	31.34	3.05	.9375-20
18	28.60	10.95	1.57	26.97	33.73	3.05	1.0625-18
20	31.78	14.12	2.38	29.41	36.90	3.05	1.1875-18
22	34.95	14.12	2.38	31.75	40.08	3.05	1.3125-18
24	38.12	14.96	2.38	34.92	43.18	3.73	1.4375-18

NOTE: Service Rating is identified on each insert arrangement

No.	Name	Material/Finish	Remarks
1	Shell	Aluminum	
2	Insert	Neoprene or Viton	
3	Contact	Copper Alloy	Ni 100μ" - Au Flash
4	Locking Post	304 Stainless Steel	

UNLESS NOTED TOLERANCES ARE: .X ± 0.38 .XX ± 0.25 ANGLES ± 1°	THIRD ANGLE PROJECTION 		1170 S. PATTON ST. XENIA, OHIO 45385 PH: (937) 374-2700 FX: (937) 374-2717	
			U N I T : mm S C A L E : NTS S H E E T : 1 OF 2	D R W N : RLM D A T E : 02/06/14 C H K ' D : RLM A P V ' D : RLM

THESE DRAWINGS AND SPECIFICATIONS ARE THE PROPERTY OF SPI AND SHALL NOT BE COPIED, USED OR RE-PRODUCED WITHOUT PERMISSION.

REVISIONS LIST				
REV	ECO #	DESCRIPTION	DATE	APV'D
A		Initial Release		
B		Revised "W" Class Back Shell	03/17/20	RLM

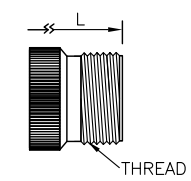

GENERAL DUTY
THREADED
[A]

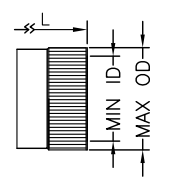

GROMMET SEAL
WITH BACK NUT
[E]

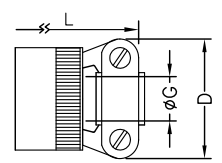

GROMMET SEAL WITH
STRAIN RELIEF
[F]

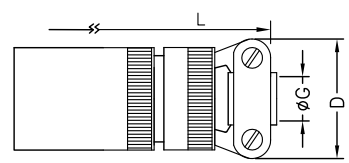

WATER TIGHT GLAND SEAL
WITH STRAIN RELIEF
[J]

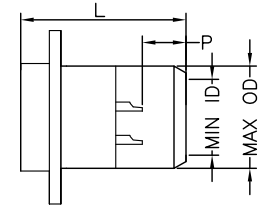

ENVIRONMENTAL
POTTING
[P]

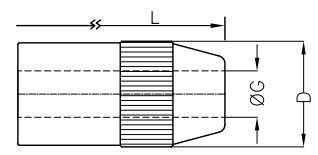

WATER TIGHT GLAND SEAL
WITHOUT STRAIN RELIEF
[W]

Shell Size	CLASS A		CLASS E			CLASS F			CLASS J				CLASS P			CLASS W				
	L Max	THREAD (UNEF2A)	L MAX	ID MIN	OD MAX	L MAX	D MAX	ØG ±.254	L MAX	D MAX	GLAND CLOSED	ØG OPEN	L MAX	ID MIN	OD MAX	P MIN	L MAX	D MAX	ØG CLOSED	ØG OPEN
8	41.00	.4375-28	33.73	6.58	15.44	48.82	21.03	3.18	57.68	21.03	4.29	5.84	36.91	8.05	15.44	6.35	46.89	14.25	4.28	5.84
10	41.00	.5625-24	33.73	9.12	18.64	48.82	22.63	4.78	57.68	22.63	5.21	7.92	39.91	11.02	18.64	6.35	46.89	17.43	5.21	7.93
12	41.00	.6875-24	33.73	11.91	21.79	48.82	25.81	7.92	61.24	25.81	8.59	11.23	36.91	13.92	21.79	6.35	49.45	20.60	8.59	11.23
14	41.00	.8125-20	33.73	14.96	24.99	48.82	28.98	9.53	66.01	28.98	10.57	13.69	36.91	17.09	24.99	6.35	54.54	23.78	10.57	13.69
16	41.00	.9375-20	33.73	18.47	28.19	51.99	30.56	12.70	74.75	30.56	13.97	15.65	36.91	20.27	28.19	6.35	59.61	26.95	13.97	15.65
18	41.00	1.0625-18	33.73	19.79	31.34	52.78	37.31	15.88	80.57	37.31	15.24	17.07	36.91	22.83	31.34	6.35	64.70	30.13	15.24	17.07
20	44.00	1.1875-18	38.89	22.89	34.54	59.54	37.31	15.88	91.69	37.31	16.13	18.97	42.47	26.01	34.54	6.35				
22	44.00	1.3125-18	38.89	25.63	37.69	59.54	42.06	19.05	95.66	42.06	17.02	21.49	42.47	29.18	37.69	6.35				
24	44.00	1.4375-18	40.49	28.52	40.89	61.11	44.45	20.32	101.22	44.45	19.30	22.69	44.04	32.36	40.89	6.35				

Name	Material/Finish	Remarks
Back Shells & Clamps	Aluminum	
Screws	Brass	
Washers	Stainless Steel	F & J Back Shells
Grommets/O-Rings	Neoprene	
Gland Seal	Silicone	

UNLESS NOTED TOLERANCES ARE: .X ± 0.38 .XX ± 0.25 ANGLES ± 1°	THIRD ANGLE PROJECTION 	 1170 S. PATTON ST. XENIA, OHIO 45385 PH: (937) 374-2700 FX: (937) 374-2717
U N I T : mm	D R W N : RLM	T I T L E 26482 Wall Mount Receptacle
S C A L E : NTS	D A T E : 02/06/14	
	C H K ' D : RLM	
S H E E T : 2 OF 2	A P V ' D : RLM	
		S P I P / N : SPI00XXX-XXXX-XX
		R E V : B
		C U S T O M E R P / N :