

REVISIONS LIST				
REV	ECO #	DESCRIPTION	DATE	APV'D
A		Initial Release		

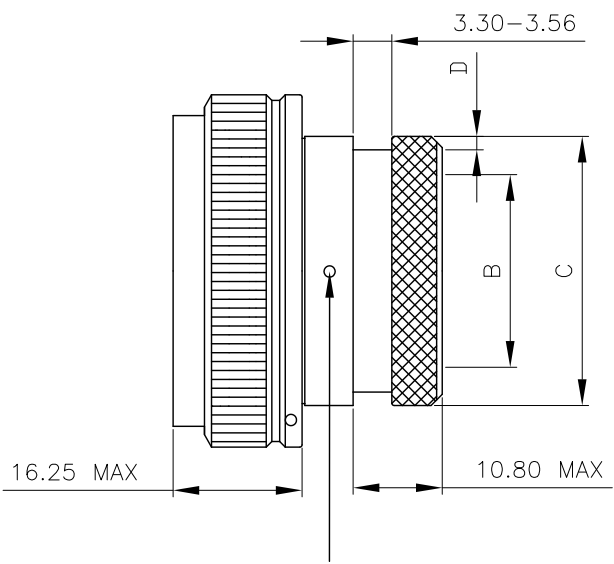

4 EQUALLY SPACED 3.18 DRAIN HOLES
OPTIONAL DRAIN HOLE "D"

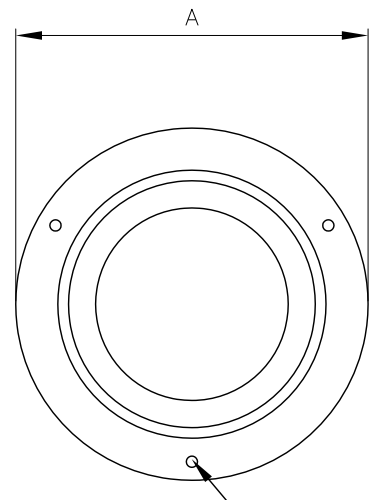

3 EQUALLY SPACED 0.51
MAX SAFETY WIRE HOLES

Dash Number	A	B	C	D
	Max	Min	Max	+0.20 / 0.0
9	19.10	6.35	13.54	1.12
11	21.60	9.52	15.37	1.12
13	25.40	12.70	19.66	1.12
15	29.20	15.88	21.29	1.12
17	31.80	19.05	24.46	1.12
19	35.60	20.62	26.47	1.12
21	39.40	23.80	30.91	1.75
23	41.90	26.97	34.42	1.75
25	47.00	30.18	36.65	1.75

No.	Name	Material/Finish	Remarks
1	Shell	Aluminum	
2	Fastners	Stainless Steel	Passivated

UNLESS NOTED
TOLERANCES ARE:
.X ± 0.38
.XX ± 0.25
ANGLES ± 1°

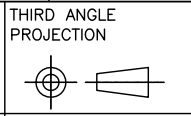

1170 S. PATTON ST.
XENIA, OHIO 45385
PH: (937) 374-2700
FX: (937) 374-2717

UNIT: mm	DRWN: RLM	THESE DRAWINGS AND SPECIFICATIONS ARE THE PROPERTY OF SPI AND SHALL NOT BE COPIED, USED OR RE-PRODUCED WITHOUT PERMISSION.	TITLE		
SCALE: NTS	DATE: 08/30/21		Commercial Back Shell		
	CHK'D: TRH		SPI P / N : SPI85049/62-XXX		REV: A
SHEET: 1 OF 1	APV'D: TRH		CUSTOMER P / N :		